

Instruction Manual

CarPlay Integration for BMW iDrive NBT System

Model No.	VI-BMW -14C
MB-SW Ver.	020001
CP-SW Ver.	C7.3
Manual Ver.	1.4
Date	Jan.29.2019

Content:

Warning	3
Compatibility	5
Features	6
Package Components	7
Connection Diagram	8
DIP Setting	10
Operation Instruction	11
How to switch from original to add-on interface	11
Apple CarPlay	12
Android Auto	13
Mirroring	14
USB Multimedia Playback	14



 **Warning:**

In order to protect the driving safety and avoid break the traffic law; please DO NOT operate the interface while driving.

The reversing surveillance function just is used in reversing assistance. Please check the entire surroundings while reversing.

All steps of installation should be done by the well-trained specialist.

During installation, the ignition key should be taken off and after all installation finished, connect power cable last.

Please DO NOT plug or pull the connected cables in the state of power-on, in order to avoid damaged monitor or accessory.

Install wiring in a manner in which cables will not come in contact with metal parts. The wiring may be damaged by contact with metal parts, resulting in fire and shocks. Avoid all contact with hot surfaces when wiring the main unit. High temperatures may damage wiring, causing shorts, arcing and fires.

Please DO NOT put the product in the damp environment or water, in order to avoid electric shock, damaged and fire accident caused by a short circuit.

Kindly check all components are in the box when receiving the product. If anything missing, inform to the supplier/manufacturer.

Start the engine before loading, check the interface whether have function displayed, key control whether correct, the vehicle



interface whether having a scratch. Please give the feedback to the supplier/manufacturer if there have any questions.

Please note that put the disassembled automotive components in a good way on the installation process, avoid scratching the instrument panel, the leftovers of connecting cables need to handle and DO NOT leave it in the car. The connecting plug must be insulated in order to short circuit.

The cables should be connected in a good way, the vehicle installation space is a little small, so reduce space usage as far as possible. There should be a good plan about connect cables, avoid affecting the active component of connecting, such as control components of turning the steering wheel, throttle and brake pedal. There need to be fastened after connecting cables in case of a drop.



Compatibility:

Brands	Series	Years	Original System
BMW	1 Series (F20)	2013 - 2017	NBT system (High-CIC) with 6.5/8.8/10.25 inch monitor 6 Pin LVDS connector
	3 Series (F30, F31)		
	4 Series (F32)		
	5 Series (F10, F11)		
	6 Series (F12)		
	7 Series (F01, F02)		
	X1 (E84)		
	X3 (F25)		
	X4 (F26)		
	X5 (F15)		
X6 (F16)			
Mini	Cooper	2013-2015	



NOTE! BMW X3, X4 with 8.8" monitor DO NOT support aftermarket rear view camera connection.

NOT available for BMW 1 series (2017) with 8.8 inch monitor.



Features:

Integrated 3 in 1 module supports Apple CarPlay, Android Auto, and screen mirroring functions

Supports USB HD video and lossless music playback (APE, WAV, FLAC, MP3, WMA, etc.)

Offers 2 CVBS video in for front/rear view camera

Support PDC (Parking Distance Control) and FPG (Flexible Parking Guidelines)

2 alternative types of reversing: full screen camera without PDC and split camera display with PDC

Supply 12V power to the backup camera

Display front view camera automatically when shifted from “R” gear (DIP setting)

VGA input for specific 360 panoramic system, offers a clearer picture

Operate by OEM iDrive controller & steering wheel buttons

Support further software update by TF card



Apple CarPlay



Android Auto



Mirroring



USB multimedia



FPG



PDC



2*CVBS in



Software update



Package Components:



Main Unit
Dimension: 143*102*26 mm



Quadlock Main Power Cable



6 Pin LVDS Cable



USB/MIC Cable

Optional Components:



External Microphone
(Needed when a car **without OEM MIC**)



3.5mm AUX Cable
(Needed when OEM Quadlock connector with **MOST Fiber Optic**)



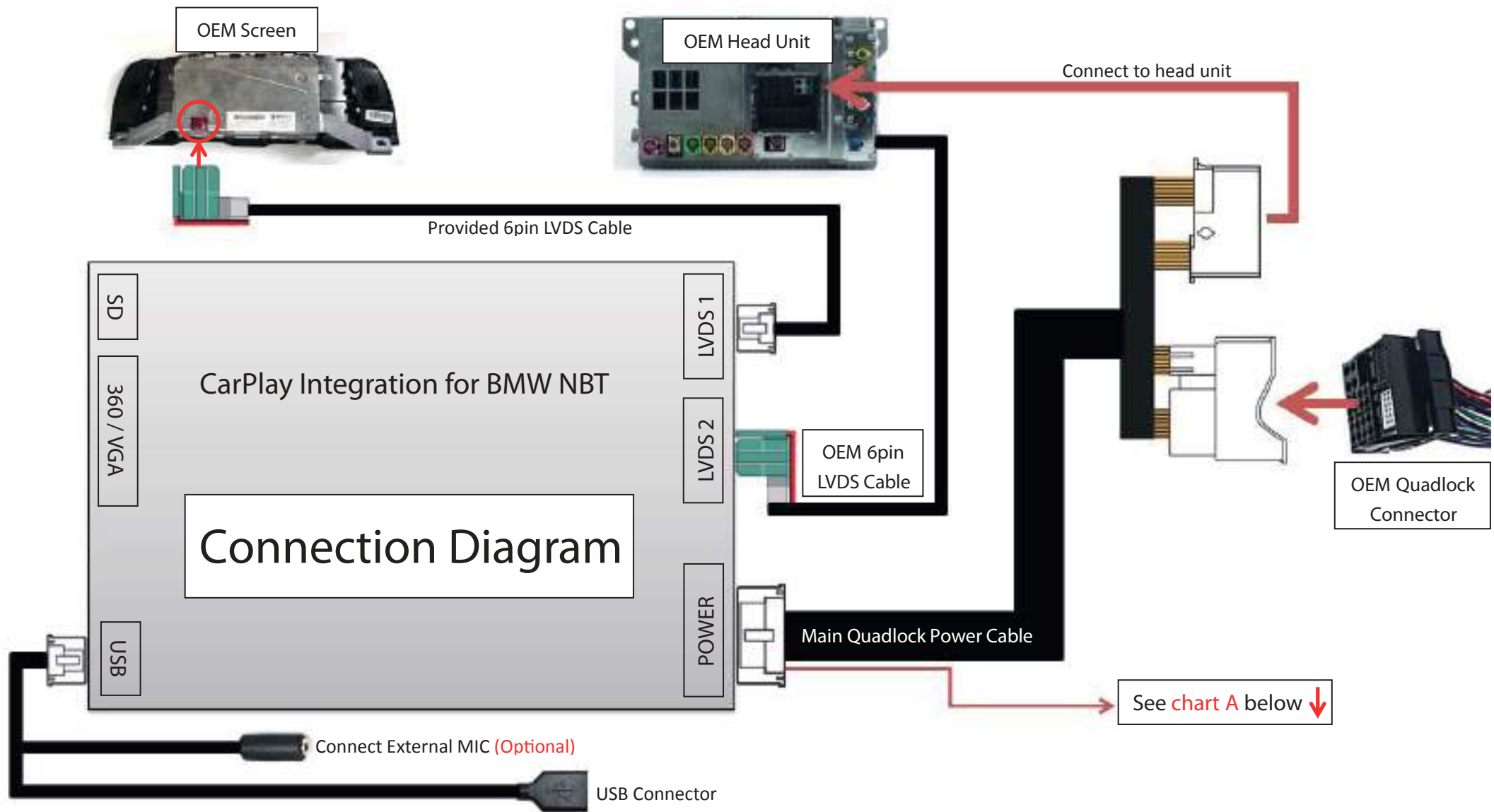

How to connect when the head unit with MOST Fiber Optic

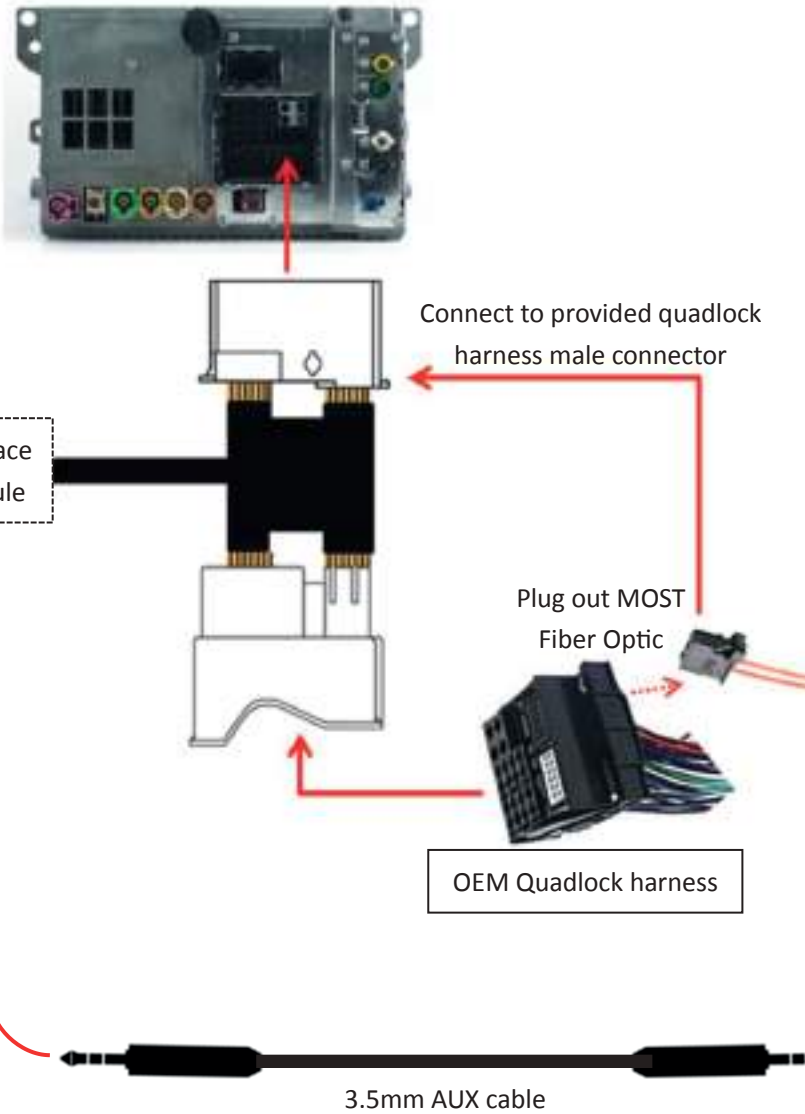

Chart A: ↓

	ACC_OUT	Supply power for DVR or other video devices. Just connect the ACC_OUT (RED) when use aftermarket front view camera
	B+	
	GND	Connect GND if there is any audio noise
	A-GND	
	LEFT_DET	N/A
	RIGHT_DET	N/A
	CAM_POWER	Supply 12V power for backup camera
	REVERSE	Reverse detect (Connect to reverse light if CAM_POWER cable does not output 12V)
	REAR_CVBS	Rear view camera video input
	FRONT_CVBS	Front view camera/DVR video input
	AUDIO OUT	AUX Audio output (Connect to "3.5mm AUX cable" only when OEM Quadlock connector with MOST Fiber Optic)



DIP Setting:



PIN	ON ↓	OFF ↑
1	Disable PDC (Parking distance control), full screen reversing	Enable PDC, split reversing with PDC
2	Disable 360 Panoramic	Enable 360 Panoramic
3	CVBS	VGA
4	Display front view camera for 10S automatically after shifted from "R" gear	Skip front view camera (Click "DVR" icon on main menu if want to display F CAM/DVR)
5	Selection of car model	
6		
7	Original Rear View Camera	Aftermarket Rear View Camera
8	External Microphone	Original Microphone

5	6	Car Models
OFF ↑	OFF ↑	2013-2015 Mini/3 Series/X3/X4 (8.8 inch) 2013-2016 X5/X6/5 Series (10.25 inch) 2013-2015 7 Series (10.25 inch) 2016 Mini/3 Series/X3/X4 (8.8 inch)
ON ↓	OFF ↑	2013-2016 1~5 Series/Mini/X3 (6.5 inch) 2016 X1 (6.5 inch)
ON ↓	ON ↓	2017 1 Series (6.5 inch)
OFF ↑	ON ↓	Reserved

NOTE! Please reboot the interface for effective after changing any DIP setting.



Operation Instruction:

How to switch from Original to Add-on interface



Order: OEM - Add on - OEM

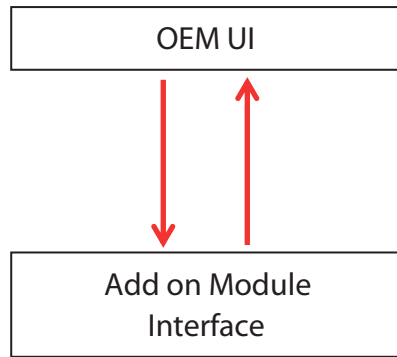

NOTE! It will switch to add on module UI automatically when a phone/USB stick connected.



Long press "MODE" on steering wheel for 10S will reboot the add on module

Add on module UI:

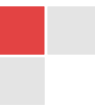
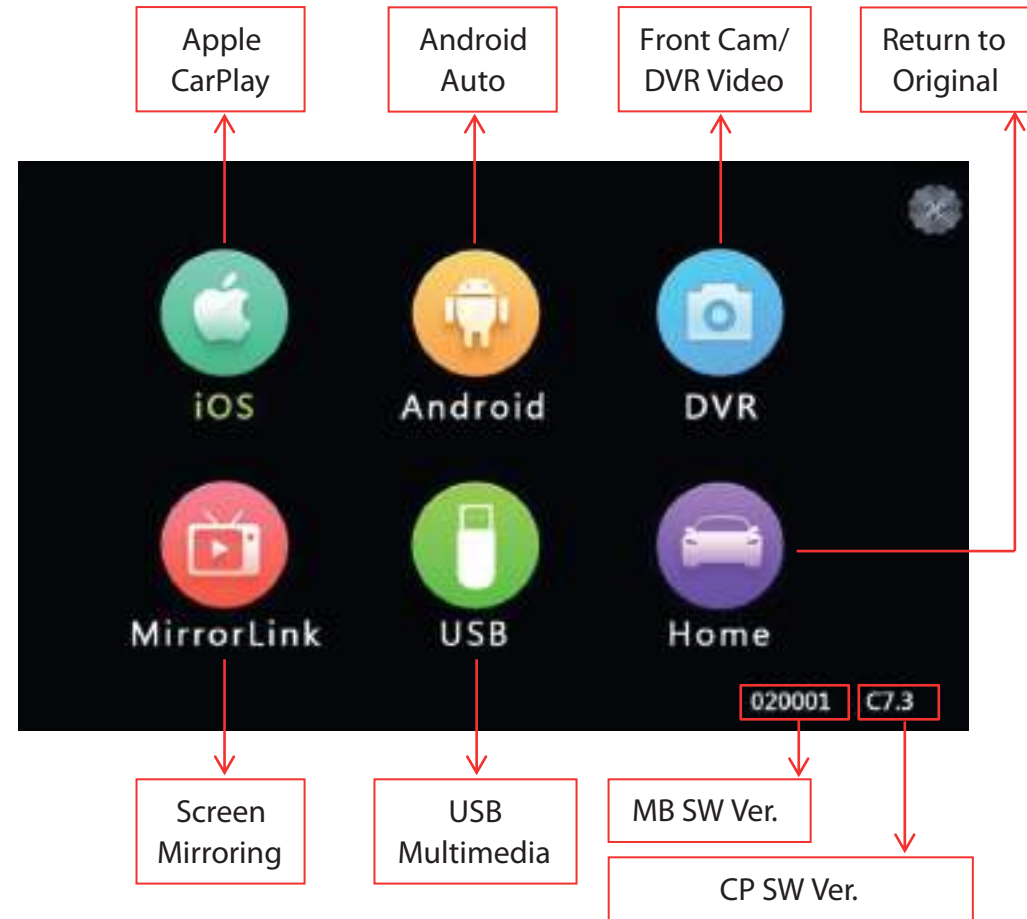

Original Audio Setting:



NOTE! Make sure switch to "AUX" mode on original car stereo before use the CarPlay integration.

Apple CarPlay

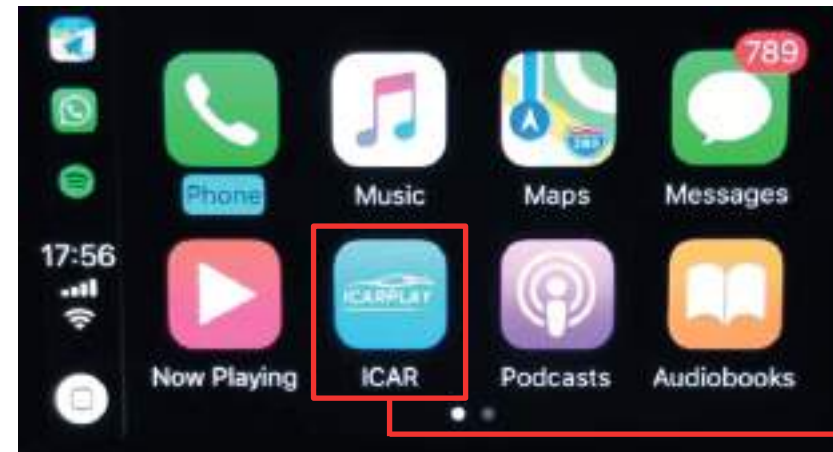

Return to add-on module UI



NOTE! Please **disconnect** the Bluetooth connection between the phone and car stereo when using Apple CarPlay.



Android Auto



A area

B area

NOTE!

Make sure smartphone connect to original car stereo Bluetooth (**Only tick CALL AUDIO, uncheck MEDIA AUDIO**) for phone call audio delivering when using Android Auto.

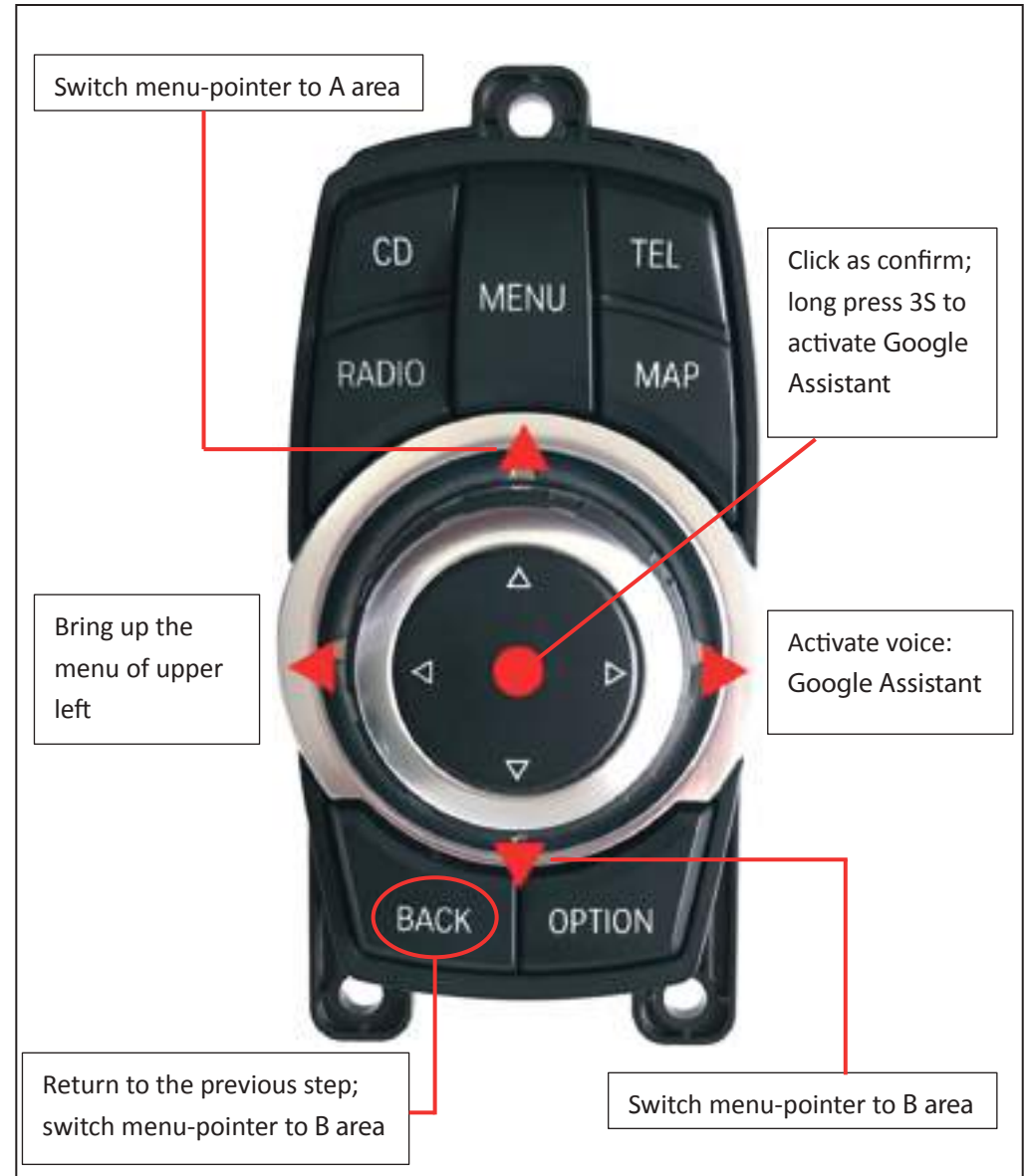

Mirroring



Connect Android smartphone/iPhone with USB cable, and then enter "MirrorLink" for screen mirroring.

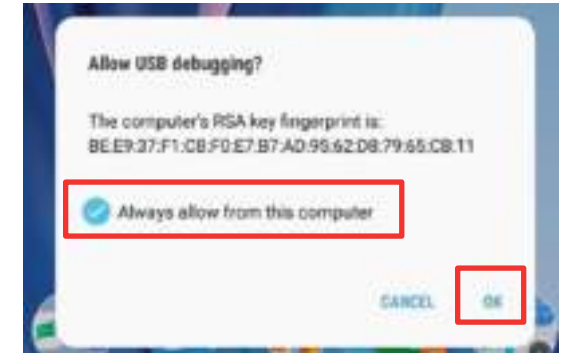

NOTE!

Please always trust or allow when display a popup notification

Enabling "USB Debugging" on an Android device

Android device must connect to car stereo BT for all audio delivering

USB Multimedia Playback



Connect a USB memory stick, enter "USB" icon for playing multimedia: Music, Picture, and Video.



Corredoira Car Audio
Poeta Noriega Varela, 4
27004 - Lugo - Spain
Tel.: 982 265 100
comunicados@grupocorredoira.com

